



These operating instructions apply to: **Series NEA**  
**Series NEG**



# Contents

<b>1</b>	<b>GENERAL INFORMATION</b>	<b>3</b>
<b>2</b>	<b>SAFETY</b>	<b>6</b>
<b>3</b>	<b>TECHNICAL DATA</b>	<b>7</b>
<b>4</b>	<b>DESIGN AND FUNCTION</b>	<b>9</b>
<b>5</b>	<b>TRANSPORT AND STORAGE</b>	<b>10</b>
<b>6</b>	<b>INSTALLATION</b>	<b>11</b>
6.1	Fixation of the vibrator	11
6.2	Electrical connections	12
<b>7</b>	<b>START-UP</b>	<b>15</b>
<b>8</b>	<b>ADJUSTMENT OF UNBALANCES</b>	<b>16</b>
<b>9</b>	<b>TROUBLESHOOTING</b>	<b>20</b>
<b>10</b>	<b>MAINTENANCE AND SERVICING</b>	<b>21</b>
<b>11</b>	<b>SPARE PARTS</b>	<b>25</b>
<b>12</b>	<b>ACCESSORIES</b>	<b>26</b>
<b>13</b>	<b>DISPOSAL</b>	<b>27</b>

## Scope of delivery

Please refer to the delivery note for the scope of delivery. Check the packaging for possible signs of transport damage.

In the event of damage to the packaging, check that the contents are complete and undamaged. If there is any damage, inform the carrier.

# 1 General information

## Use and storage

Before using the electric external vibrators of the series NEG read this operating manual carefully. It is the basis for any action taken with regard to the NEG and may be used for training purposes. The operating manual should subsequently be stored near the NEG.

## Target group

The target group for these operating instructions is qualified technical personnel who have basic knowledge in electrics and mechanics.

Therefore, only staff who are qualified in these fields may perform work on the NEA and NEG.

The NEA and NEG may only be mounted, put into operation, maintained, troubleshot and disassembled by persons who have been authorised by the operator.

## Copyright

This documentation is subject to copyright. **NetterVibration** reserves all rights including those to translations, reproduction and duplication of the operating instructions, as well as parts thereof.

## Limitation of liability

All technical information, data and instructions on installation, operation and maintenance in these operating instructions are based on the latest information available at the time of printing and take our past experience to the best of our knowledge into account.

No claims can be derived from the information, illustrations and descriptions in these operating instructions.







The manufacturer does not assume liability for damages resulting from:

- failure to observe the operating instructions
- improper use
- unauthorised repairs
- technical modifications
- use of inadmissible spare parts

Translations are made to the best of our knowledge.

**NetterVibration** does not assume liability for translation errors, even if the translation was made by us or on our behalf. Only the original German text is binding.

The following instruction and warning symbols are used in these operating instructions:

	<b>DANGER</b>	indicates a possible explosion which will result in death or personal injury if the instruction is not followed.
	<b>WARNING</b>	indicates a possible danger which can result in personal injury, and/or material damage if the instruction is not followed.
	<b>HOT SURFACE</b>	indicates a possible danger which can result in personal injury, and/or material damage if the instruction is not followed.
	<b>DISCONNECT POWER SUPPLY</b>	indicates a possible danger which can result in personal injury if the instruction is not followed.
	<b>IMPORTANT</b>	Note with especially useful information and tips.
	<b>ENVIRONMENTALLY SAFE DISPOSAL</b>	indicates the obligation of an environmentally safe disposal.

## Information on the NEA and NEG

Netter electric external vibrators of the series NEA and NEG comply with the EC machinery directive 2006/42/EC, the electromagnetic compatibility directive 2014/30/EU and the low voltage directive 2014/35/EU.

In particular, the standards DIN EN ISO 12100, DIN EN 60529 and DIN EN 60034-1 have been complied with.

The electric external vibrators of the series NEA and NEG comply with the directive 2014/34/EU for the equipment group II and are suitable for use in potentially explosive areas of the category 3D in the zone 22. The standards DIN EN 60079-0 and 60079-31 in particular have been observed.

### Special features:

- adjustable centrifugal force
- all vibrators are impregnated for tropical use by vacuum casting or by trickle impregnation.
- 100% duty cycle
- degree of protection IP 66 (DIN EN 60529), housing size 50 and 60: degree of protection IP 65
- insulation class F
- high rate of efficiency due to silicon electrical sheets
- terminal box integrated in housing foot (housing sizes 101 to 120)
- smallest mounting dimensions
- stainless steel covers
- sound level measured in the open  $\leq 70$  dB(A) according to IEC
- from housing size 170 upwards, equipped with PTC thermistors by default
- earthing screw on housing and in terminal box

## 2 Safety

### Intended use:

The vibrators are intended for installation in machines according to the equipment group and category. These machines use vibrations for sieving, loosening, conveying, compacting and separating bulk materials.

Any other use is considered improper.

### Qualification of the personnel:

Assembly, commissioning, maintenance and trouble-shooting of the vibrators may only be performed by authorised qualified personnel.

Any handling of the electric vibrators lies within the responsibility of the operator.

Accessories which ensure correct operation and safety must provide the protection type required for the specific use.



**NetterVibration** assumes no liability for personal injuries and material damages if technical modifications on the product were made or the notices and regulations in these operating instructions were not observed.



The electrical external vibrators are built according to current EC directives. Before using these vibrators in potentially explosive dusty atmospheres, the operator must exclude the possibility that the introduction of vibrational energy poses the risk of explosion.

Installation and operation of the vibrators must be carried out in accordance with the ATEX regulations for operation in potentially explosive dust atmospheres, the rules and regulations of the local associations for electrical engineering (e.g. VDE) and the known accident prevention regulations.



Live parts can cause severe or even fatal injury.



DISCONNECT  
POWER  
SUPPLY

When working on the vibrators, they must be safely disconnected from the electrical mains. Proceed as follows:

1. Switch off vibrator.
2. Secure against unintentional switching on.
3. Determine that the NEA and NEG are voltage-free.
4. Earth and short-circuit.
5. Cover and fence off neighbouring live parts.



HOT  
SURFACE

The vibrators must not be touched during operation or shortly after being switched off. The surface temperature of the vibrators can reach such high values during operation that there is a risk of burning.



**Netter electric external vibrators generate vibrations.**

The operator of vibration systems must protect workers against actual or potential hazards to their health and safety due to the effects of vibration.

### 3 Technical data

#### Permissible operating conditions

##### Nominal voltage, nominal frequency:

The mains voltage and the mains frequency must comply with the nominal voltage and nominal frequency indicated on the type plate.

Series NEA und NEG:

Voltage and frequency: see details on type plate.

Power supply with:

- fixed voltage and frequency or
- frequency converter

The operation of three-phase vibrators of the series NEG with frequency converters allows rotary speeds > nominal frequency.

If the electric external vibrators are operated with a frequency converter, compliance with the EMC directive has to be ensured.

In zone 22 the frequency converter may regulate the frequency between 20 Hz and 50 Hz or 20 Hz and 60 Hz (please check max. frequency on type plate) at a constant torque load (linear volt-hertz-curve).

##### Rotary speed ranges:

2-pole 3000 rpm 50 Hz / 3600 rpm 60 Hz

4-pole 1500 rpm 50 Hz / 1800 rpm 60 Hz

6-pole 1000 rpm 50 Hz / 1200 rpm 60 Hz

8-pole 750 rpm 50 Hz / 900 rpm 60 Hz



WICHTIG

##### Permissible ambient temperature:

-20 °C to 40 °C\* or

-20 °C to 55 °C\*

The maximum ambient temperature specified on the type plate must not be exceeded.

These values are valid for operation with an ON-period of 100 %.

Cycled or frequency-controlled operation or synchronous operation is subject to specific requirements. These must be clarified with **NetterVibration** on a case-by-case basis.

These electric vibrators must not be used in environments with a highly explosive gas atmosphere.

##### Thermal overload protection:

From housing size 170 upwards with thermistors type PTC 130 °C as standard.

For smaller vibrators: available on request as initial equipment.

If the vibrator is operated in environments with potentially explosive dust (zone 22), it is mandatory to connect the PTC-thermistor. This regulation does not apply if the unit is not equipped with a PTC-thermistor.

##### Sound level:

Depending on type  $\leq 70$  dB(A)

The sound level is determined to a great extent by the surface upon which the vibrator is mounted (e.g. sheet metal). The sound level will be amplified by non-silenced sheet metal.

\*) Higher temperatures are only possible after consultation with and written approval from the application technicians of **NetterVibration**.

Please refer to the type plate for the technical data of your electric external vibrator.

**Type plate for sizes 50 and 60**

- type designation ⇨
- rotary speed ⇨
- nominal voltage ⇨
- current ⇨
- phases ⇨
- serial number ⇨

<b>NetterVibration</b> Germany, 55252 Mainz-Kastel Tel.: +49 6134 2901-0 					
CE  II 3D Ex tc IIIC T100°C Dc IP65					
Type		Duty		%	
n	min <sup>-1</sup>	Fc		N	
U	V	f		Hz	
I	A	P		kW	
Ph		Ins. Cl.			
No.		Year			Prot.

- ⇨ duty cycle
- ⇨ centrifugal force
- ⇨ nominal frequency
- ⇨ power
- ⇨ insulation class
- ⇨ year of manufacture / degree of protection

**Type plate from size 100 on**

- type designation ⇨
- nominal voltage ⇨
- current ⇨
- phases / capacity ⇨
- power factor ⇨
- year of manufacture ⇨
- serial number ⇨

<b>NetterVibration</b> Germany, 55252 Mainz-Kastel, Tel.: +49 6134 2901-0 					
CE  II 3D Ex tc IIIC °C Dc					
Type		Duty	100	%	
U	V	Fc		N	
I	A	n	min <sup>-1</sup>	f	Hz
Ph	Cap. μF	P <sub>in</sub>			kW
cos φ		P <sub>out</sub>			kW
Year		Ins. Cl.	F	Prot.	IP66
No.		Max. Amb.			°C

MAY BE USED WITH PWM INVERTER -CT- 20 HZ TO BASE FREQUENCY  
 CAUTION: USE SUPPLY WIRE SUITABLE FOR 105°C

- ⇨ temperature class T (D)
- ⇨ duty cycle
- ⇨ centrifugal force
- ⇨ rotary speed / nom. frequency
- ⇨ power input
- ⇨ power output
- ⇨ insul. class / degree of protection
- ⇨ max. ambient temperature

For detailed technical data of vibrators please refer to our leaflet.



## 4 Design and function

- The **electric motor** for the series NEA is a three-phase asynchronous motor (capacitor included on the supply cable or in the capacitor box).  
The **electric motor** for the series NEG is a three-phase asynchronous motor.
- To achieve a high rate of efficiency at a low motor temperature, the stators of the asynchronous motors are made of an electrical steel sheet with a low dissipation factor.
  - A special quality feature is the stator, which has been cast under vacuum with resin. The dried resin bonds housing and stator together to form an inseparable unit, which is robust and tropical proof. From housing size 140 upwards the stators are trickle impregnated. This method also completely fills the spaces between the individual windings and achieves high mechanical reliability.
- Motor protection by incorporated PTC-thermistor 130°C; as standard from size 170 upwards (DIN 44081 and DIN 44082).
- Protection by housing “tD” for use in areas with potentially explosive dust atmosphere.
- The **motor shaft** is made of heat-treated alloyed steel.
- The **special bearings** are over-dimensioned and designed for heavy loads and high frequencies.
- All units are ideally suited for **speed control** with frequency converters.
- The  **housings** of the sizes 50 to 140 and 160 are made of an aluminum alloy.
- The  **housings** of the sizes 150 and 170 to 210 are made of high-tensile nodular cast iron.
- Due to powder coating the **paint finish** is highly weather resistant as well as resistant against abrasion, impacts and a wide variety of chemicals.  
Colour: traffic black.
- The **unbalance masses** are adjustable as follows:
  - type XS continuously adjustable
  - type XLs in steps of 20°
  - type XL by removable discs
- The **covers of the unbalances** are made of stainless steel.

## 5 Transport and storage



Check the packaging for possible shipping damage.  
If damage to the packaging is found check the content for completeness and possible damage. In case of damage inform the freight forwarder.

The units are packed ready for installation. The type plate is attached to the vibrator. If not otherwise specified, the vibrator is delivered with an unbalance setting of 100 %.

When transporting the vibrator make sure to avoid hard impacts or vibrations which could damage the bearings.

The unit should be stored in a clean, dry environment.

If the vibrator needs to be in storage for a longer period of time (2 years max.), the temperature in the storage area must not fall below -15 °C or be above +60 °C and the relative air humidity must not exceed 60 %.



If the vibrator is operated in areas with potentially explosive dust (zone 22), maintenance by **NetterVibration** is mandatory after a storage period of more than a year.



The transport eyes are for exclusively lifting the vibrator.  
If the vibrator is fitted with two transport eyes, both must be used for lifting. The pulling direction must not exceed 45°.



## 6 Installation



**IMPORTANT**

The installation of the vibrators must only be carried out by authorised, qualified staff.  
The staff has to work exclusively with tools suitable for the application.



**IMPORTANT**

During installation please comply strictly with the safety regulations in chapter 2 and the accident prevention rules!  
Installation of the system must be performed in compliance with the local, applicable regulations (e.g. VDE-regulations).

### 6.1 Fixation of the vibrator

Netter electric external vibrators can be operated in any position.  
During installation the following notes must be strictly observed:



**WARNING**

The mounting surfaces must be absolutely level ( $\pm 0.1$  mm flatness fault), so that the feet of the vibrators have full area contact and to avoid tension in the housing when tightening the fastening screws. The surfaces should also be free of any paint residues and branding. Tensions in the housing can cause mechanical and/or electrical damage.

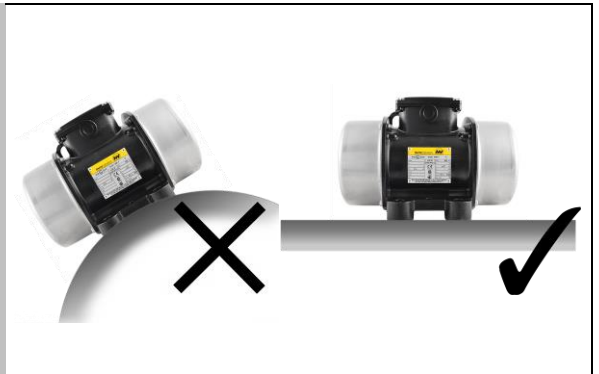

For safe fastening we recommend the use of Netter NBS screw connections consisting of a screw, a special lock washer and, if applicable, a nut.

The vibrators can also be fastened with fastening screws of quality 8.8 (DIN 931 or 933). These must be secured with appropriate locking devices and checked and retightened at regular intervals (usually monthly).



**WARNING**

The tightening torques can be found in the following table. Higher tightening torques may cause fracture of screws or tearing of threads. Unsuitable screw connections may cause loosening of the vibrators by vibration. This can cause damage to persons and material!



### Recommended tightening torques for fastening screws and nuts [Nm]

(screws as supplied, without additional lubrication):

Type of screw	M6	M8	M10	M12	M16	M20	M22	M24
Property class 8.8 [Nm]*	10	25	50	87	210	411	559	711
Stainless steel screws [Nm]	8,8	21,4	44	74	183	-	-	-

\* coefficient of sliding friction  $\mu = 0,14$

Use a torque wrench and tighten the screws crosswise.

Use an additional safety device with steel cable for critical installation situations, e.g. NSE.



Use the wire cable clamps to set the safety cable to the shortest possible cable length.

**The safety cable must always be tensioned!**

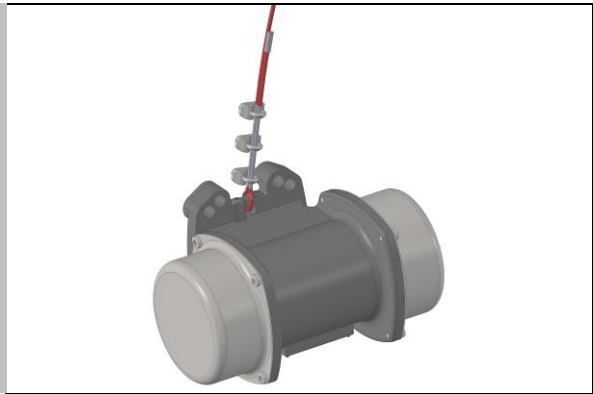

## 6.2 Electrical connections



**IMPORTANT**

The electrical installation of the vibrators must be performed only by authorised, qualified staff.  
The staff has to work exclusively with tools suitable for the application.



**IMPORTANT**

The mains voltage and the mains frequency have to correspond to the nominal voltage and frequency indicated on the type plate.  
A voltage tolerance of  $\pm 5\%$  or a frequency tolerance of  $\pm 2\%$  are permissible.

### Connection examples for NEG

The vibrator circuitry must be connected according to the type plate as follows:

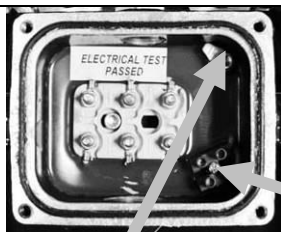

PTC-thermistor

The green-yellow conductor is the protective earth and must only be connected to the earthing terminal.

Further connection plans (e.g. for special voltages) on request.

#### Series NEG / 3-phase current

smaller voltage

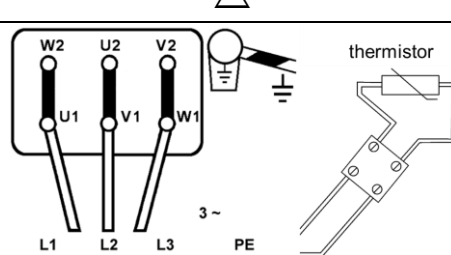

higher voltage

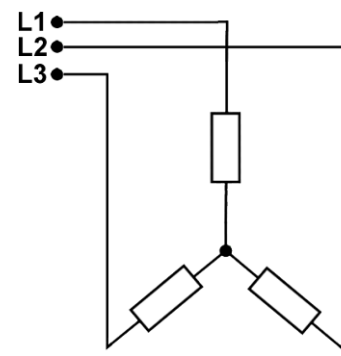
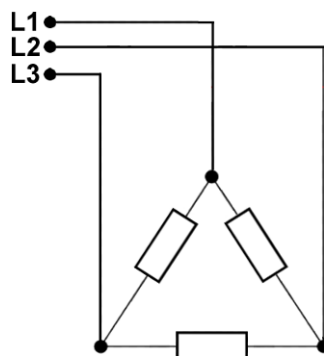
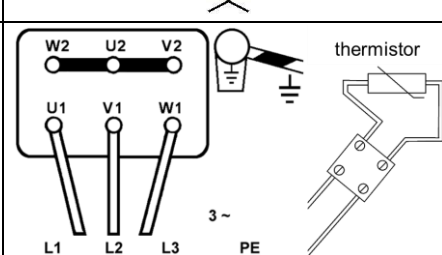

Connection example for NEA

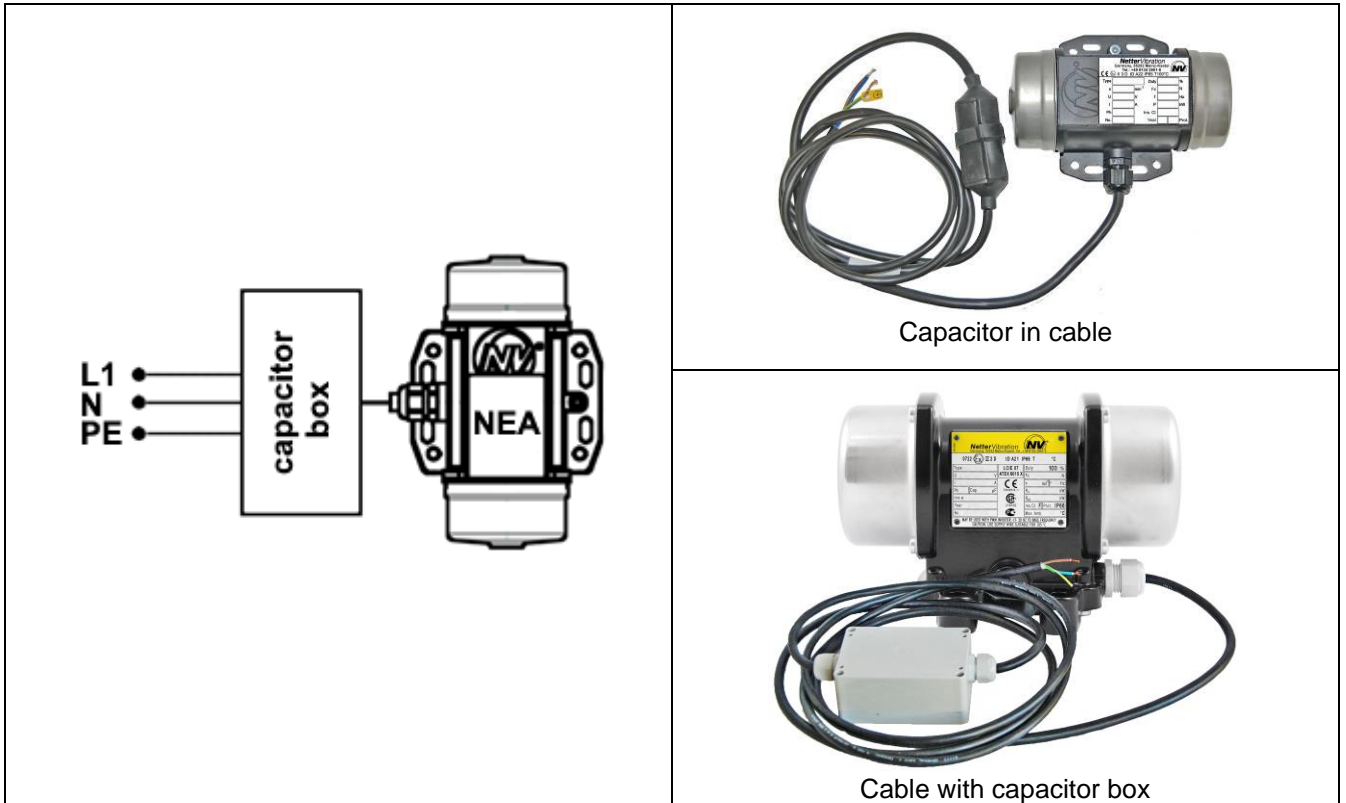

**IMPORTANT**

A suitable overload protection must be pre-connected to each vibrator. The motor protection switches must be interlocked with each other in pairs, so that in the event of a motor failure, the power supply from both motors is interrupted at the same time in order not to cause uncontrolled vibrations which can damage the system.



**DANGER**

In zone 22 the motor circuit breakers must be approved for applications in potentially explosive atmospheres.

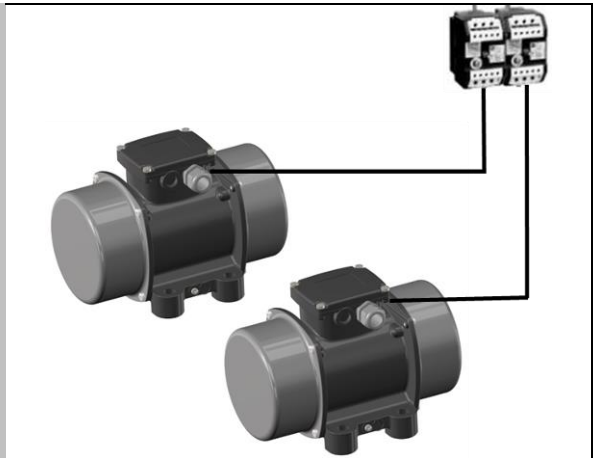

**DANGER**

In zone 22, an external grounding must also be made via the earth connection on the housing foot.

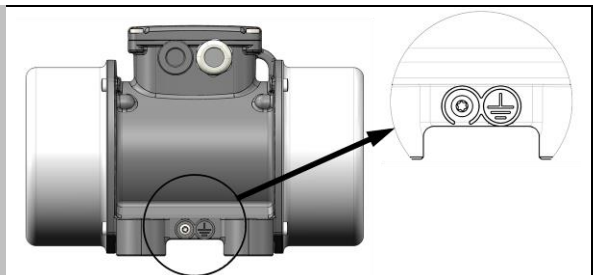



**Thermic overload protection:**

Standard equipment with PTC-thermistor 130°C from housing size 170 upwards.

For smaller vibrators: available on request as initial equipment.

**If the vibrator is operated in areas with potentially explosive dust (zone 22), it is compulsory to connect the PTC-thermistor. This regulation does not apply for units without a PTC-thermistor.**



Only suitable, flexible supply cables must be used for connecting the vibrators.

The conductors in the supply cable for the connection of the vibrators to the mains must be temperature-resistant and have a sufficiently large cross-section, which is adapted to the cable length used. The temperature resistance of the cables depends on the maximum surface temperature stated on the type plate.

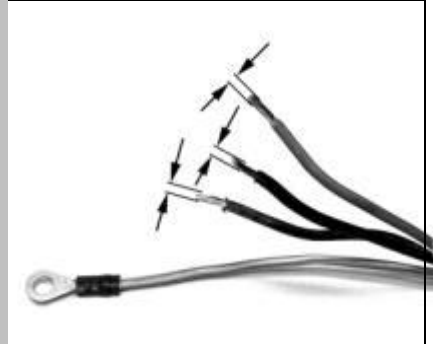

When selecting the connection cables, consider that the cables are mechanically stressed by vibration.

Recommended cable types for mains operation at 400 V, in potentially non-explosive atmosphere: rubber hose line H07 RN-F or oil flex cable 110 CY.

For other voltages or other ambient conditions, the cables must be adapted to the respective conditions and designed accordingly.



The terminal box cover may not be opened in a potentially explosive atmosphere or when voltage is applied.

If the terminal box cover or unbalance covers are open, check the condition and correct positioning of the seals. Damaged seals must be replaced immediately.

**WARNUNG** **WARNING**

Nicht öffnen in explosionsfähiger Atmosphäre.

Do not open in an explosive atmosphere

Cable temperature near the cable gland: 120 °C



The electrical cables must be carefully laid. Care must be taken to ensure that the cables are not chafed through by vibrating parts.

The correct condition of the electrical cables with their plugs must be checked at regular intervals (usually every six months). Detected errors are to be eliminated immediately. Protect the cable from high temperatures, lubricants and sharp edges.



Tighten terminal plate nuts with prescribed torque. Remember to put the safety washer between the ring and the nut and the vibration-damping insert back.

- M 4 ⇒ 1,2 Nm
- M 5 ⇒ 2,0 Nm
- M 6 ⇒ 3,0 Nm
- M 8 ⇒ 6,5 Nm
- M 10 ⇒ 13,5 Nm

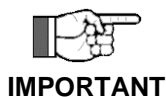
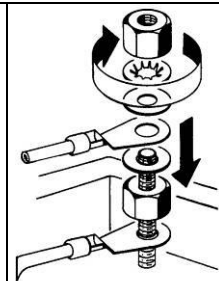

The wire ends must be fitted with insulated cable lugs, in order to prevent the strands from splaying. The maximum size of the cable lugs can be found in the following table:

- Set screw M4 max. AWG 18
- Set screw M5 max. AWG 16
- Set screw M6 max. AWG 12
- Set screw M8 max. AWG 12



## 7 Start-up

When commissioning the vibrators, the rules and regulations of the local associations for electrical engineering (e.g. VDE) and the valid accident prevention regulations must be observed.



**IMPORTANT**

The vibrators must always be switched on and off at the main switch.

When operating the external electric vibrators with a frequency converter, compliance with the EMC directive must be ensured.

If the speed is controlled with a frequency converter, the maximum centrifugal force must not be exceeded. The unbalances must be reduced if necessary.



**WARNING**

The vibrators must not be operated without the covers for the unbalances! The rotating unbalances cause a risk of injury!

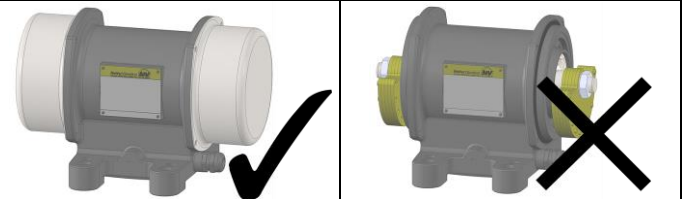

In zone 22, the frequency converter may control the frequency between 20 Hz and 50 Hz or 20 Hz and 60 Hz at constant torque (linear Volt-Hertz curve). Observe maximum frequency on the type plate.



**DANGER**

Explosion-protected vibrators may only be operated in atmospheres that do not damage the material of the equipment.

The terminal box cover must never be opened in a potentially explosive atmosphere or in the presence of voltage.

The supplementary regulations and instructions applicable in Ex-areas must be observed.



**DANGER**

On initial start-up, the current consumption must be measured individually in all three phases and must correspond to the specifications on the type plate.



**WARNING**

The vibrators must be adapted to your application by adjusting the unbalances. You can directly influence the oscillation bandwidth, centrifugal force and current consumption, see chap. 8 "Adjustment of unbalances".

### **Retightening:**

Screw connections must be checked and, if necessary, retightened after 1 h operating time (after initial commissioning) and thereafter regularly (generally monthly).



## 8 Adjustment of unbalances



For all vibrators of the series NEA and NEG, there is the possibility of unbalance adjustment.

Unless otherwise specified by you, the units were delivered with the standard setting (100 %).

By adjusting the unbalances, you can directly influence oscillation bandwidth, centrifugal force and current consumption.



For all devices, the unbalances may only be set mirror-symmetrically!

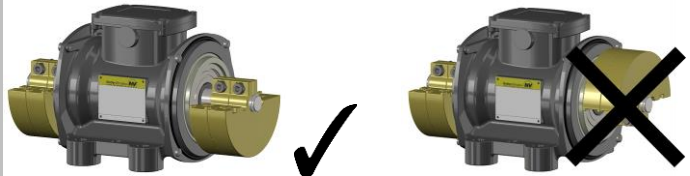

The tables below show the type of unbalance and the number of unbalances per vibrator at the default setting of 100%.

Type	Unbalance		
	Type	Quantity	
		50 Hz	60 Hz
NEA 504	XL	8	8
NEA 5020	XL	8	8
NEA 5050	XL	18	18

NEA 5060	XLs	4	4
----------	-----	---	---

NEA 50120	XLs	6	6
NEA 50200	XLs	10	8
NEA 50300	XLs	8	6
NEA 50550	XLs	10	6
NEA 50770	XLs	8	6
NEA 2530	XLs	6	6
NEA 2570	XLs	16	10
NEA 25210	XS	4	4
NEA 25420	XS	4	4
NEA 25540	XS	4	4
NEA 25700	XS	4	4

Type	Unbalance		
	Type	Quantity	
		50 Hz	60 Hz
NEG 5020	XL	8	8
NEG 5050	XL	18	18

NEG 5060	XLs	4	4
----------	-----	---	---

NEG 50120	XLs	6	6
NEG 50200	XLs	10	8
NEG 50300	XLs	8	6
NEG 50550	XLs	10	6
NEG 50770	XLs	8	6
NEG 501140	XLs	12	8

NEG 501540	XLs	12	8
NEG 501800	XLs	14	10
NEG 502020	XLs	16	10
NEG 502270	XLs	18	12
NEG 503400	XLs	12	8
NEG 503820	XLs	14	10

NEG 506220	XS	4	4
NEG 508830	XS	4	4

Type	Unbalance		
	Type	Quantity	
		50 Hz	60 Hz
NEG 2530	XLs	6	6
NEG 2570	XLs	16	10

NEG 25210	XS	4	4
NEG 25420	XS	4	4
NEG 25540	XS	4	4
NEG 25700	XS	4	4
NEG 25930	XS	4	4
NEG 251410	XS	4	4
NEG 251800	XS	4	4
NEG 252060	XS	4	4
NEG 252370	XS	4	4
NEG 253050	XS	4	4
NEG 253720	XS	4	4
NEG 254310	XS	4	4
NEG 254900	XS	4	4
NEG 256460	XS	4	4
NEG 258040	XS	4	4
NEG 258260	XS	4	4
NEG 2511210	XS	4	4
NEG 2513850	XS	4	4

NEG 1630	XLs	8	8
----------	-----	---	---

NEG 1690	XS	4	4
NEG 16190	XS	4	4
NEG 16310	XS	4	4
NEG 16410	XS	4	4
NEG 16500	XS	4	4
NEG 16810	XS	4	4
NEG 161130	XS	4	4
NEG 161420	XS	4	4
NEG 161610	XS	4	4
NEG 162110	XS	4	4
NEG 162550	XS	4	4
NEG 163030	XS	4	4
NEG 163820	XS	4	4
NEG 164700	XS	4	4
NEG 165190	XS	4	4
NEG 166270	XS	4	4
NEG 166670	XS	4	4
NEG 167890	XS	4	4
NEG 168500	XS	4	4
NEG 169510	XS	4	4
NEG 1612060	XS	4	4
NEG 1613890	XS	4	4
NEG 1617000	XS	4	4

Type	Unbalance		
	Type	Quantity	
		50 Hz	60 Hz
NEG 12100	XS	4	4
NEG 12180	XS	4	4
NEG 12230	XS	4	4
NEG 12460	XS	4	4
NEG 12640	XS	4	4
NEG 12900	XS	4	4
NEG 121430	XS	4	4
NEG 122150	XS	4	4
NEG 122640	XS	4	4
NEG 122920	XS	4	4
NEG 123530	XS	4	4
NEG 124440	XS	4	4
NEG 127640	XS	4	4
NEG 128520	XS	4	4
NEG 1211070	XS	4	4
NEG 1213160	XS	4	4
NEG 1217670	XS	4	4

### Procedure:

- Switch off vibrator, secure against unintentional starting and ensure that there is no voltage.
- Loosen both covers for the unbalances.
- Loosen the locking nuts or locking screws.
- Adjust the lamella discs or cast-iron unbalances as required.
- Retighten the locking nuts or locking screws.
- Fasten the covers for the unbalances.



## Unbalance discs of the type XL

The centrifugal force is adjustable with the unbalance lamella discs of type XL in the following steps:

Number of unbalance discs per side	15	100									
	14	93									
	13	87	100								
	12	80	92	centrifugal force in %							
	11	73	85	100							
	10	67	77	91	100						
	9	60	69	82	90	100					
	8	53	62	73	80	89	100				
	7	47	54	64	70	78	88	100			
	6	40	46	55	60	67	75	86	100		
	5	33	38	45	50	56	63	71	83	100	
	4	27	31	36	40	44	50	57	67	80	100
	3	20	23	27	30	33	38	43	50	60	75
	2	13	15	18	20	22	25	29	33	40	50
	1	7	8	9	10	11	13	14	17	20	25
	30   26   22   20   18   16   14   12   10   8										
	Default number of unbalance discs per vibrator										

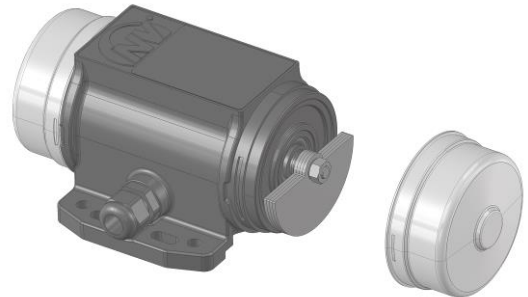

There are 2 possibilities to adjust the unbalances:

1. The unbalance adjustment (fine adjustment) is carried out by removing one lamella disc on each side. All centrifugal values in % can be adjusted as specified in the table. The removed lamella discs must be replaced by compensation washers (available from **NetterVibration**) of identical thickness and identical inner diameter.
2. The unbalance adjustment (coarse adjustment) is performed by turning one lamella disc on each side by 180° on the shaft. Twice the number of lamella discs turned by 180° becomes ineffective.

### Unbalance lamella discs of the type XLs

Adjustment of the unbalances is carried out according to a scale disc or the supplementary sheet in the terminal box of the unit. By rotating the outer, adjustable unbalance disc(s) to another position, the percentage of the centrifugal force changes as shown in the illustration below. The grid position is defined by position pins.

Settings:

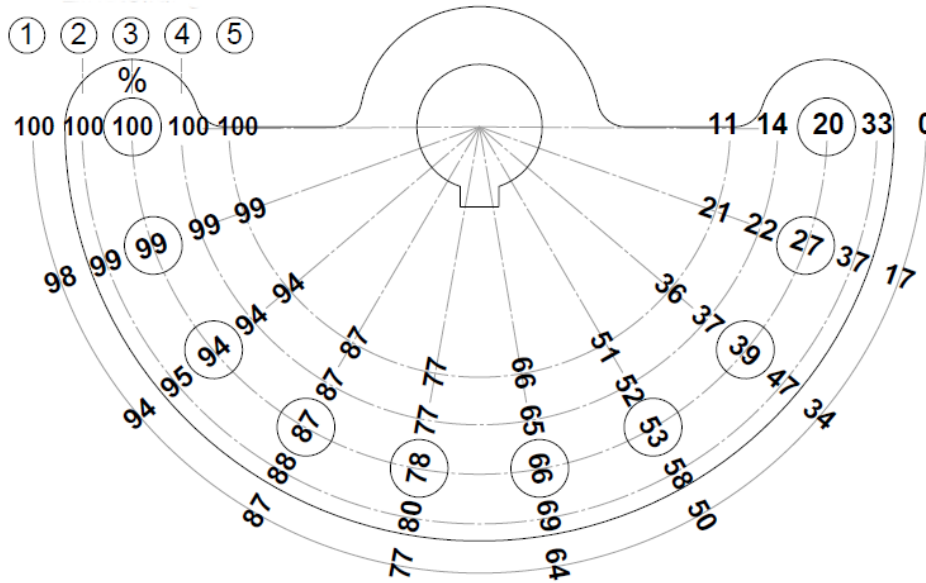

settings	unbalance per side		type				50 Hz	60 Hz
	fixed	adjustable						
①	1	1	NEG 5060				x	x
	2	2	NEG 50200	NEG 501140	NEG 501540	NEG 503400		x
			NEG 1630				x	x
			NEG 50300	NEG 50770			x	
			NEG 501140	NEG 501540	NEG 503400		x	
3	3	NEG 502270					x	
4	4	NEG 2570	NEG 502020			x		
②	2	1	NEG 50120	NEG 2530			x	x
			NEG 50300	NEG 50770				x
			NEG 50550					x
			NED 50100					
③	3	2	NEG 50200	NEG 50550			x	
			NEG 2570	NEG 501800	NEG502020	NEG 503820		x
			NED 50200					
④	4	3	NEG 501800	NEG 503820			x	
⑤	5	4	NEG 502270				x	

Example:

The NEG 50120/50 Hz has a total of 6 unbalance discs (3 discs per side: 2 fixed, 1 adjustable). If a centrifugal force of 88% is desired, the adjustable unbalance discs are rotated anticlockwise on both sides into the fourth grid position.



## Unbalance discs of the type XS

The unbalance setting of the unbalance discs of the type XS is carried out on the scale on the fixed unbalance.

The centrifugal force can be steplessly adjusted by turning the outer unbalance discs and adjusting them at the partial strokes. After adjusting the unbalances, the nuts and screws must be tightened with the specified torque.



The centrifugal force can be adjusted with the unbalance discs of the type XS according to the following table:

adjustment	centrifugal force in %
0°	100
15°	98,5
30°	97
45°	92
60°	87
75°	78,5
90°	70

adjustment	centrifugal force in %
105°	60
120°	50
135°	37,5
150°	25
165°	12,5
180°	0

## Recommended average tightening torques for fastening screws and nuts [Nm]

Screw type	M6	M8	M10	M12	M16	M20	M22	M24
strength class 8,8 *	10	25	50	87	210	411	559	711
strength class 12,9 **	-	-	43	84	148	370	700	1250

\* coefficient of sliding friction  $\mu = 0,14$

\*\* coefficient of sliding friction  $\mu = 0,15$

For screw types M8 to M14 strength class 12.9 is used as standard.

## 9 Troubleshooting



Troubleshooting may only be carried out by authorised qualified staff.  
The qualified personnel must only use tools suitable for the application.

<b>Fault</b>	<b>Possible cause</b>	<b>Troubleshooting</b>	<b>Action</b>
Vibrator does not start or runs at too low speed	Phase interruption	Check fuse and connecting cable	Replace fuse and/or connecting cable
	Mains voltage too low	Check mains voltage and cable cross-section	Check if mains voltage is correct, replace cable
Vibrator speed drops under load	Wiring wrong	Check circuit diagram	
	Inadequate contact of a connection point	Check connection in terminal box	Tighten terminal nuts
	Phase interruption	Check fuse and connecting cable	Replace fuse or connecting cable
	Incorrectly dimensioned connecting cable	Check cable cross-section	Replace cable
	Overload	Check setting of unbalances	Reduce unbalances
	Mains voltage too low	Check mains voltage and cable cross-section	Check if mains voltage is correct, replace cable
One phase without current	Phase interruption	Check the connecting cable	Replace cable
Excessive heating of stator winding	Wiring wrong	Check circuit diagram	
	Overload		
	Mains voltage too low	Check mains voltage and cable cross-section	Check if mains voltage is correct, replace cable
Vibrator hums	Phase interruption	Check fuse, mains voltage and connecting cable	Correct mains voltage, replace fuse and/or cable
	Short-circuit between turns in the stator winding	Replace vibrator	
Circuit breaker fails when switched on	Phase interruption	Check fuse and connecting cable	Replace fuse and/or cable
	Overload	Check unbalance settings	Reduce unbalance
	Short circuit in winding	Replace vibrator	
High current consumption	Natural resonance range of vibration system	Measure current consumption	Stiffen device
	Bounce impacts	Measure current consumption	Reduce power of vibrator
		Loose fastening	Tighten screws
Bearings too warm	Too much grease in bearings	Fill in correct amount of grease: Klueber Staburags NBU 8 EP.	
	No grease in bearings	Fill in correct amount of grease: Klueber Staburags NBU 8 EP.	
	Foreign body in bearings	Clean bearings, replace if necessary.	

## 10 Maintenance and servicing



**DISCONNECT  
POWER  
SUPPLY**

When working on the vibrators, these must be safely disconnected from the electrical mains. The procedure is as follows:

1. Switch off vibrator.
2. Secure against unintentional switching on.
3. Determine that NEA and NEG are voltage-free.
4. Earth and short-circuit.
5. Cover and fence off neighbouring live parts.

The following maintenance work must be carried out regularly by trained personnel with extensive knowledge of EN 60079-17 (zone 22):

- a) Check the screw connections
- b) Check the ball and roller bearings
- c) Relubricate roller bearings
- d) Check operating hours (bearing life)
- e) Check cable supply line
- f) Replace O-rings and plastic seals every two years



**WARNING**

**Other maintenance and repair work are to be carried out exclusively by *NetterVibration*.**

Authorised and specialised staff may also perform the following work on the vibrators:

The adjustment of the unbalance discs with the removal of the unbalance covers.

The electric connection with the removal of the terminal block cover.

**Please observe the safety instructions in chapter 2 when service on the unit is done.**



**WARNING**

### **Retightening:**

Screw connections must be checked and, if necessary, retightened after 1 h operating time (after initial commissioning) and thereafter regularly (generally monthly). Observe the specified torques (see chapter 6.1).



**DANGER**

The condition of the ball and roller bearings must be checked regularly.

The replacement of defective bearings or bearings which have reached the end of their service life must be made by ***NetterVibration***.

## Lubrication

Vibrators up to the housing size 130 have ball bearings. These are lubricated for their service life (permanent lubrication).

Roller housings are mounted from housing size 130 up. These are lubricated with the grease of the type KLUEBER Staburags NBU 8 EP. This grease has the advantage that the bearings are lubricated for a period of at least 5000 operating hours (up to 3000 rpm). After this time the grease of the bearings has to be replaced completely.

Vibrators with speeds above 3000 rpm are to be lubricated regularly, i.e. every 1000 operating hours, with grease of the type KLUEBER Isoflex NBU 15.

The lubrication intervals must be considerably shortened under more difficult operating conditions.

## Service life of ball and roller bearings

When operating in a potentially explosive dust atmosphere, the operator must regularly check the condition of the bearings and the duration of operation of the vibrators.

Vibrators with damaged bearings or with bearings whose service life has been reached, must be sent immediately to **NetterVibration** for replacement.

## Grease quantity during lubrication and replacement of bearings and bearing life

Type	Grease quantity [g]	bearing life 50 Hz [h]	bearing life 60 Hz [h]
NEA 504	perm. lubrication	> 100.000	> 100.000
NEA 5020	perm. lubrication	92.118	22.745
NEA 5050	perm. lubrication	8.087	2.236
NEA 5060	perm. lubrication	> 100.000	5.044
NEA 50120	perm. lubrication	18.075	18.075
NEA 50200	perm. lubrication	3.363	2.572
NEA 50300	perm. lubrication	4.003	3.588
NEA 50550	perm. lubrication	4.148	4.219
NEA 50770	perm. lubrication	7.509	6.257

NEA 2530	perm. lubrication	> 100.000	> 100.000
NEA 2570	perm. lubrication	> 100.000	> 100.000
NEA 25210	perm. lubrication	23.406	19.200
NEA 25420	perm. lubrication	15.135	12.635
NEA 25540	perm. lubrication	6.266	4.224
NEA 25700	perm. lubrication	19.477	16.231

NEG 5020	perm. lubrication	92.118	22.745
NEG 5050	perm. lubrication	8.087	2.236
NEG 5060	perm. lubrication	> 100.000	5.044
NEG 50120	perm. lubrication	18.075	18.075
NEG 50200	perm. lubrication	3.363	2.572
NEG 50300	perm. lubrication	4.003	3.588
NEG 50550	perm. lubrication	4.148	4.219
NEG 50770	perm. lubrication	7.509	6.257
NEG 50980	9	5.062	4.833
NEG 501140	9	3.029	2.298
NEG 501540	16	4.038	3.856
NEG 501800	16	2.416	1.833
NEG 502020	30	7.070	8.372
NEG 502270	30	4.775	4.558
NEG 503400	40	8.672	10.267
NEG 503820	40	5.856	5.591
NEG 506220	120	5.743	4.636
NEG 508830	150	9.029	2.790

NEG 2530	perm. lubrication	> 100.000	> 100.000
NEG 2570	perm. lubrication	> 100.000	> 100.000
NEG 25210	perm. lubrication	23.406	19.200
NEG 25420	perm. lubrication	15.135	12.635
NEG 25540	perm. lubrication	6.266	4.224
NEG 25700	perm. lubrication	19.477	16.231
NEG 25930	9	12.103	10.190
NEG 251410	16	10.870	8.330
NEG 251800	30	22.231	20.009
NEG 252060	30	14.300	12.300
NEG 252370	35	16.159	13.032
NEG 253050	35	7.100	5.900

Type	Grease quantity [g]	bearing life 50 Hz [h]	bearing life 60 Hz [h]
NEG 253720	40	12.228	11.086
NEG 254310	40	8.200	7.300
NEG 254900	80	9.930	8.648
NEG 256460	120	10.478	8.451
NEG 258040	150	9.029	7.575
NEG 258260	180	11.460	7.881
NEG 2511210	260	10.576	8.718
NEG 2513850	300	9.000	6.200

NEG 1630	perm. lubrication	> 100.000	> 100.000
NEG 1690	perm. lubrication	> 100.000	> 100.000
NEG 16190	perm. lubrication	> 100.000	72.171
NEG 16310	perm. lubrication	> 100.000	> 100.000
NEG 16410	9	> 100.000	> 100.000
NEG 16500	9	> 100.000	39.516
NEG 16810	perm. lubrication	> 100.000	60.144
NEG 161130	perm. lubrication	54.020	42.632
NEG 161420	perm. lubrication	25.100	20.000
NEG 161610	30	29.165	29.270
NEG 162110	30	11.800	10.400
NEG 162550	32	17.701	12.292
NEG 163030	32	41.500	30.500
NEG 163820	60	13.073	10.842
NEG 164700	80	18.364	15.425
NEG 165190	100	19.206	15.157
NEG 166270	120	15.786	13.144
NEG 166670	120	13.767	14.000
NEG 167890	150	14.431	12.276
NEG 168500	150	11.266	9.379
NEG 169510	180	10.728	10.972
NEG 1612060	260	11.000	11.800
NEG 1613890	300	13.327	11.510
NEG 1617000	360	11.273	10.404

NEG 12100	perm. lubrication	> 100.000	> 100.000
NEG 12180	perm. lubrication	> 100.000	> 100.000
NEG 12230	9	> 100.000	> 100.000
NEG 12460	perm. lubrication	> 100.000	> 100.000
NEG 12640	perm. lubrication	> 100.000	> 100.000
NEG 12900	30	> 100.000	65.414
NEG 121430	32	> 100.000	39.702
NEG 122150	60	> 100.000	29.320
NEG 122640	80	> 100.000	41.200
NEG 122920	100	> 100.000	43.076
NEG 123530	120	> 100.000	35.405
NEG 124440	150	> 100.000	32.368
NEG 127640	180	29.652	10.982
NEG 128520	260	52.762	18.667
NEG 1211070	300	37.822	15.233
NEG 1213160	360	35.257	12.684
NEG 1217670	400	22.520	9.347

## Recommended tightening torques for screws (item 12 and item 22)

Screw type	M6	M8	M10	M12	M16	M20	M22	M24
strength class 8,8 *	10	25	50	87	210	411	559	711
strength class 12,9 **	-	-	43	84	148	370	700	1250

\* coefficient of sliding friction  $\mu = 0,14$

\*\* coefficient of sliding friction  $\mu = 0,15$

## Recommended tightening torques for nuts (item 25)

Nuts	M13x1	M15x1	M20x1	M25x1,5	M30x2	M45x1,5
Tightening torque	30	50	100	170	340	500

**Procedure for lubrication and replacement of bearings:**

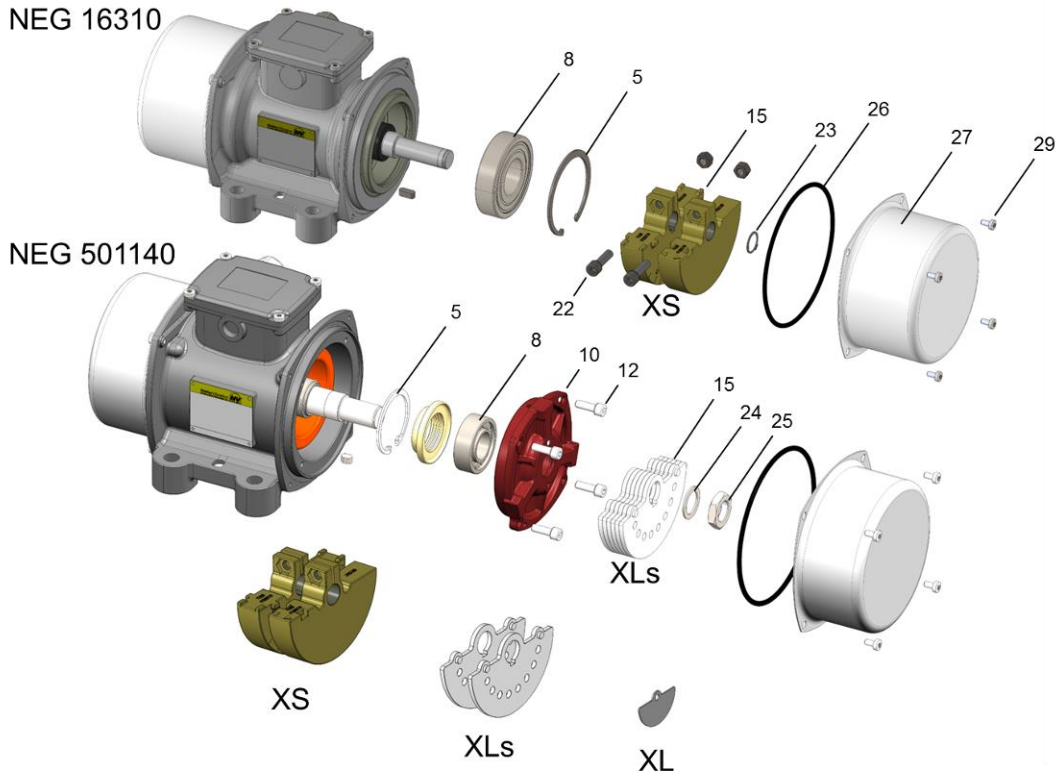

1. Switch off vibrator, secure against switching on again and ensure that it is volt-free.
2. Loosen Allen screws (29) and remove unbalance covers (27).
3. Dismantle unbalances:

**Unbalances of the types XL and XLs (15):**

Screw a long screw with the same thread into a tapped hole for the fastening screws (29) of the unbalance cover. Put a lever between the unbalance discs and this screw. After loosening the locking nut (25), the unbalances can be removed from the shaft.

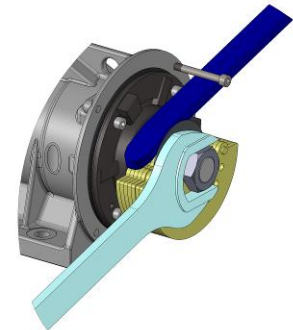

**Unbalances of the type XS (15):**

After removing the circlip (23) and loosening the clamping screws (22), the unbalances can be removed.

4. Remove bearing (8):
  - Remove circlip (5) up to housing size 120.
  - Starting from housing size 130, loosen Allen screws (12) and remove flange (10). Remove circlip (5) from flange (10).
5. Replace both bearings (8) or remove old grease (e.g. with benzine) and smear the specified amount (see table) of new grease (Klueber Staburags NBU 8 EP) evenly.
6. Assembly is carried out in the reverse order.
7. Tighten locking nuts (25) and Allen screws (12, 22) to the specified tightening torque.

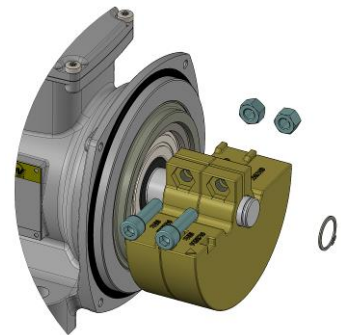



## 11 Spare parts

When ordering spare parts please provide the following details:

1. Type of unit
2. Description and position of spare part
3. Required number of parts
4. Serial number

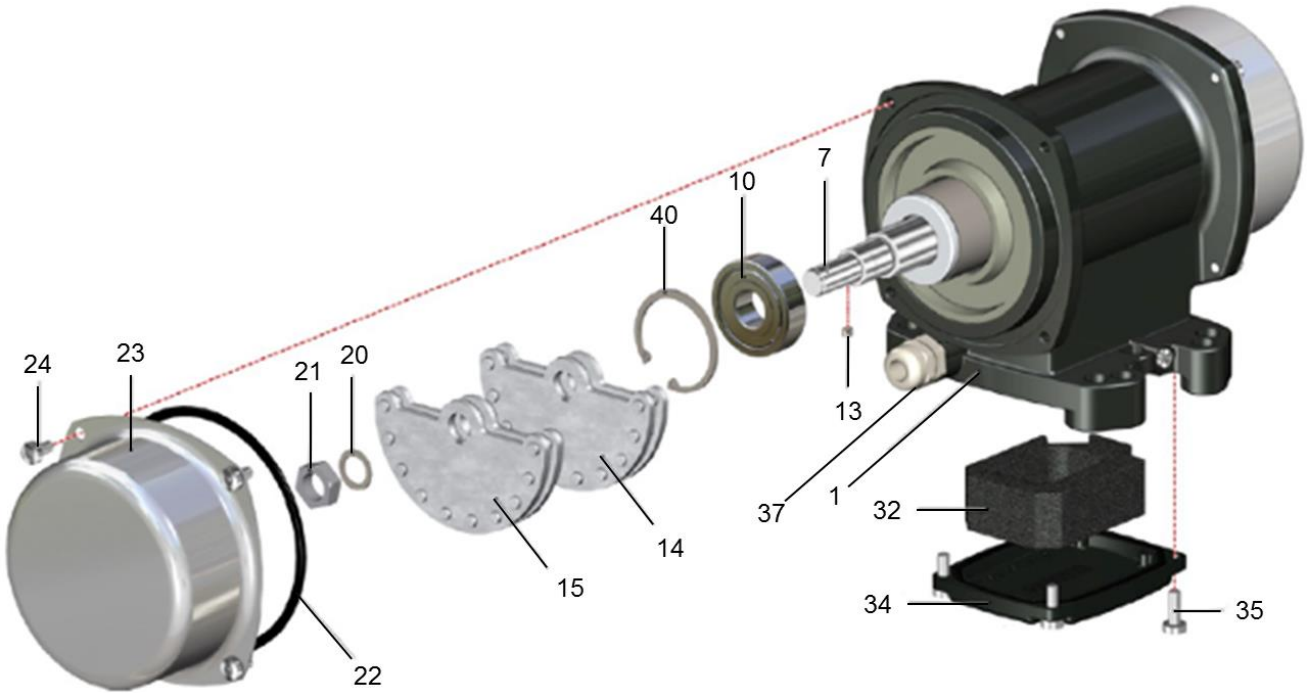

Example NEG 50300

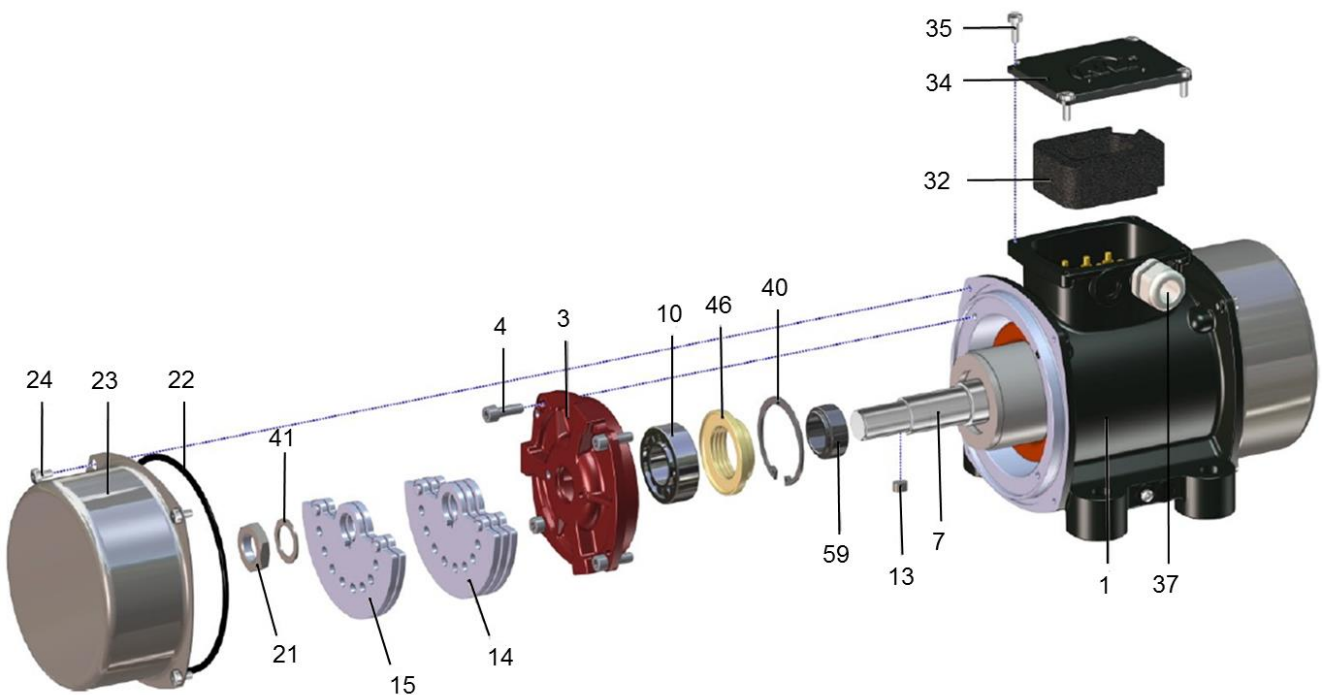

Example NEG 501140

## 12 Accessories

The following accessories are available for electric external vibrators of the series NEA and NEG:

<b>Description</b>	<b>Comment</b>
Shim washers	Compensation for removed unbalance discs
CC-unbalances	Depending on the direction of rotation, two different torques can be achieved.
Fastening sets NBS	For secure fastening of electric external vibrators
Frequency converters	For frequency-controlled operation
Brake accessories	Enable rapid deceleration of vibrators
Special versions	Electric external vibrators are also available in special versions, e.g. for special voltages or the use in potentially explosive atmospheres. Information on request.
PTC thermistor	PTC 120°C thermistor for safe operation of the vibrators

Further electrotechnical accessories on request.

### 13 Disposal

Depending on the material, the parts and packaging must be disposed of in an environmentally friendly way.

#### Material specifications:

	NEA	NEG housing types I, II and III	NEG housing type IV
Stainless steel	unbalance covers	unbalance covers	
Steel	rotor, unbalance, flange, bearings, screws, washers, nuts	housing sizes 140 and 160, rotor, unbalance, flange, bearings, screws, washers, nuts	rotor, unbalance cover, unbalance, flange, bearings, screws, washers, nuts
Aluminium	housing, type plate	housing, type plate terminal box cover	housing sizes 150 and 170 up to 210, cover for unbalances, type plate, terminal box cover
PTFE, PU, VITON	seals terminal box block	seals terminal box block	seals terminal box block
Copper with resin	winding	winding	winding



**ENVIRONMENTALLY FRIENDLY DISPOSAL**

All units can be disposed of by **NetterVibration**.  
The valid disposal prices are available on request.

**Further information available on request:  
Leaflet no. 8 (Netter Electric External Vibrators) , and more.**